





















## 5/2-directional valve, Series TC15

- Operating voltage 24 V DC
- 5/2
- Qn = 1500 l/min
- Pilot valve width : 15 mm
- Pipe connection
- Compressed air connection output : G 1/4
- Electrical connection : Plug, ISO 15217, form C
- Manual override : without detent
- single solenoid double solenoid
- Pilot : Internal External



Type	Spool valve, positive overlapping
Activation	Electrically
Sealing principle	Soft sealing
Working pressure min./max.	See table below
Control pressure min./max.	See table below
Ambient temperature min./max.	-10 ... 50 °C
Medium temperature min./max.	-10 ... 50 °C
Medium	Compressed air
Max. particle size	5 µm
Oil content of compressed air	0 ... 5 mg/m <sup>3</sup>
Nominal flow Qn	1500 l/min
Connector standard	ISO 15217
Protection class with connection	IP65
Duty cycle	100 %
Mounting on manifold strip	P-strip
Mounting screw tightening torque	2,5 Nm
Weight	See table below
Comment	An example configuration is illustrated. The delivered product may thus deviate from the illustration.

## Technical data

Part No.		MO	Compressed air connection	
			Input	Output
0820058101			G 1/4	G 1/4
0820058151			G 1/4	G 1/4
0820058126			G 1/4	G 1/4
R422103064			G 1/4	G 1/4
0820058176			G 1/4	G 1/4
R422103066			G 1/4	G 1/4
0820058601			G 1/4	G 1/4
R422103068			G 1/4	G 1/4
0820058651			G 1/4	G 1/4
R422103070			G 1/4	G 1/4

Part No.	Compressed air connection	
	Exhaust	Pilot Input
0820058101	G 1/4	-
0820058151	G 1/4	M5
0820058126	G 1/4	-
R422103064	G 1/4	-
0820058176	G 1/4	M5
R422103066	G 1/4	M5
0820058601	G 1/4	-
R422103068	G 1/4	-
0820058651	G 1/4	M5
R422103070	G 1/4	M5

Part No.	Operational voltage	Voltage tolerance	Power consumption	Pilot
0820058101	24 V	-10% / +10%	2 W	Internal
0820058151	24 V	-10% / +10%	2 W	External
0820058126	24 V	-10% / +10%	2 W	Internal
R422103064	-	-	-	Internal
0820058176	24 V	-10% / +10%	2 W	External
R422103066	-	-	-	External
0820058601	24 V	-10% / +10%	2 W	Internal
R422103068	-	-	-	Internal
0820058651	24 V	-10% / +10%	2 W	External
R422103070	-	-	-	External

Part No.	Flow conductance	Flow conductance	Nominal resistance	Working pressure min./max.
	b	C-value		
0820058101	0,33	6,8 l/(s*bar)	280 Ω	2,5 ... 10 bar
0820058151	0,33	6,8 l/(s*bar)	280 Ω	-0,9 ... 10 bar
0820058126	0,33	6,8 l/(s*bar)	280 Ω	3 ... 10 bar
R422103064	0,33	6,8 l/(s*bar)	-	3 ... 10 bar
0820058176	0,33	6,8 l/(s*bar)	280 Ω	-0,9 ... 10 bar
R422103066	0,33	6,8 l/(s*bar)	-	-0,9 ... 10 bar

Part No.	Flow conductance	Flow conductance	Nominal resistance	Working pressure min./max.
	b	C-value		
0820058601	0,33	6,8 l/(s*bar)	280 Ω	2 ... 10 bar
R422103068	0,33	6,8 l/(s*bar)	-	2 ... 10 bar
0820058651	0,33	6,8 l/(s*bar)	280 Ω	-0,9 ... 10 bar
R422103070	0,33	6,8 l/(s*bar)	-	-0,9 ... 10 bar

Part No.	Control pressure min./max.	Typ. switch-on time	Typ. switch-off time
0820058101	2,5 ... 10 bar	21 ms	22 ms
0820058151	2,5 ... 10 bar	21 ms	22 ms
0820058126	3 ... 10 bar	12 ms	35 ms
R422103064	3 ... 10 bar	12 ms	35 ms
0820058176	3 ... 10 bar	12 ms	35 ms
R422103066	3 ... 10 bar	12 ms	35 ms
0820058601	2 ... 10 bar	10 ms	10 ms
R422103068	2 ... 10 bar	10 ms	10 ms
0820058651	2 ... 10 bar	10 ms	10 ms
R422103070	2 ... 10 bar	10 ms	10 ms

Part No.	basic valve with electrical connector	Weight
0820058101	-	0,235 kg
0820058151	-	0,235 kg
0820058126	-	0,235 kg
R422103064	Basic valve without coil	0,235 kg
0820058176	-	0,235 kg
R422103066	Basic valve without coil	0,235 kg
0820058601	-	0,263 kg
R422103068	Basic valve without coil	0,263 kg
0820058651	-	0,263 kg
R422103070	Basic valve without coil	0,263 kg

Nominal flow Qn at 6 bar and  $\Delta p = 1$  bar, MO = Manual override

## Technical information

The min. control pressure must be adhered to, since otherwise faulty switching and valve failure may result!

The pressure dew point must be at least 15 °C under ambient and medium temperature and may not exceed 3 °C .

The oil content of compressed air must remain constant during the life cycle.

Use only the approved oils from AVENTICS. Further information can be found in the "Technical information" document (available in the MediaCentre).

## Technical information

Material	
Housing	Polyamide fiber-glass reinforced
Seals	Acrylonitrile butadiene rubber Hydrogenated nitrile butadiene rubber
Front plate	Polyamide fiber-glass reinforced

Material	
Threaded bushing	Brass Die cast zinc, nickel-plated chrome-plated

## Dimensions

### dimensions, single solenoid

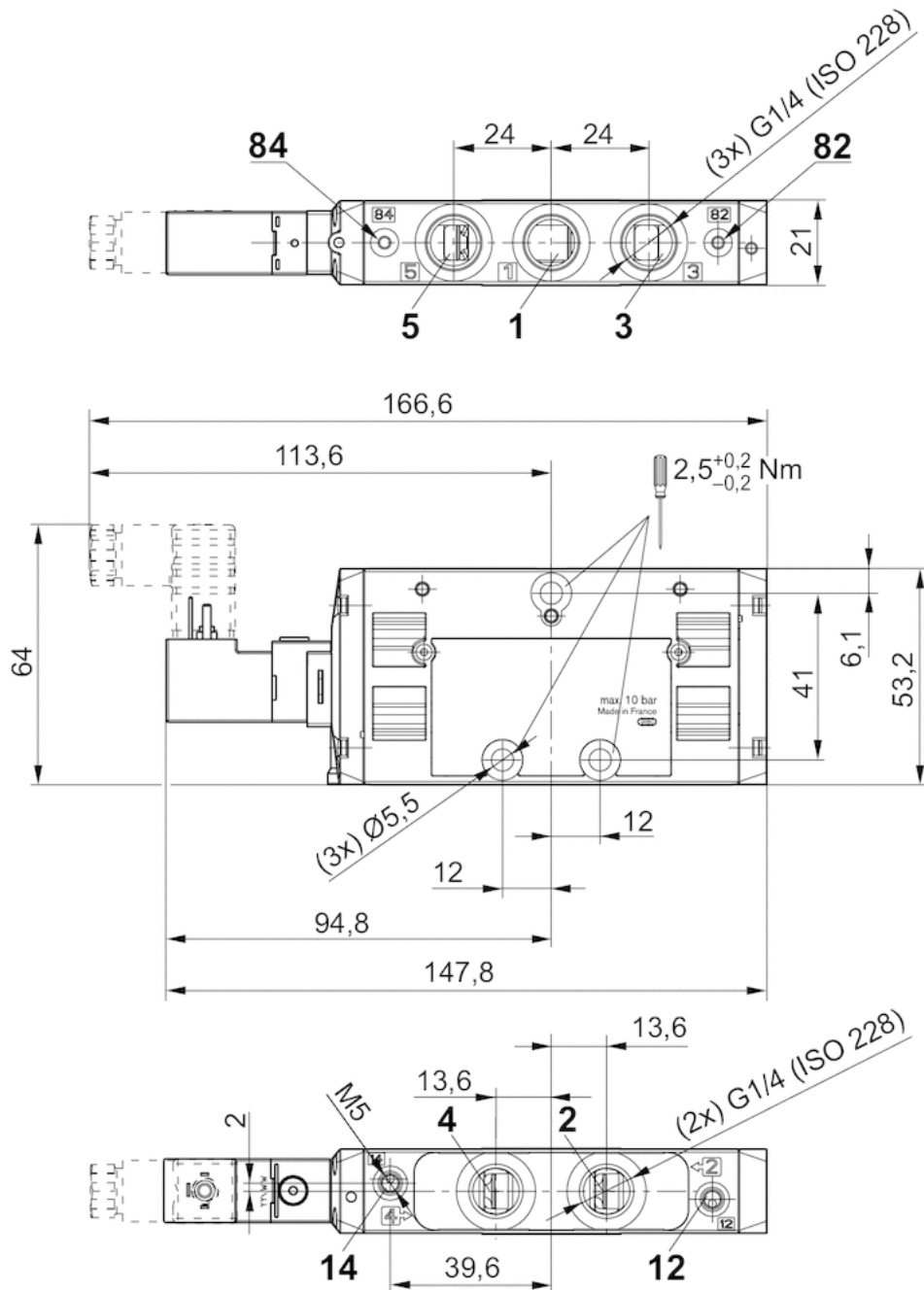

dimensions, double solenoid

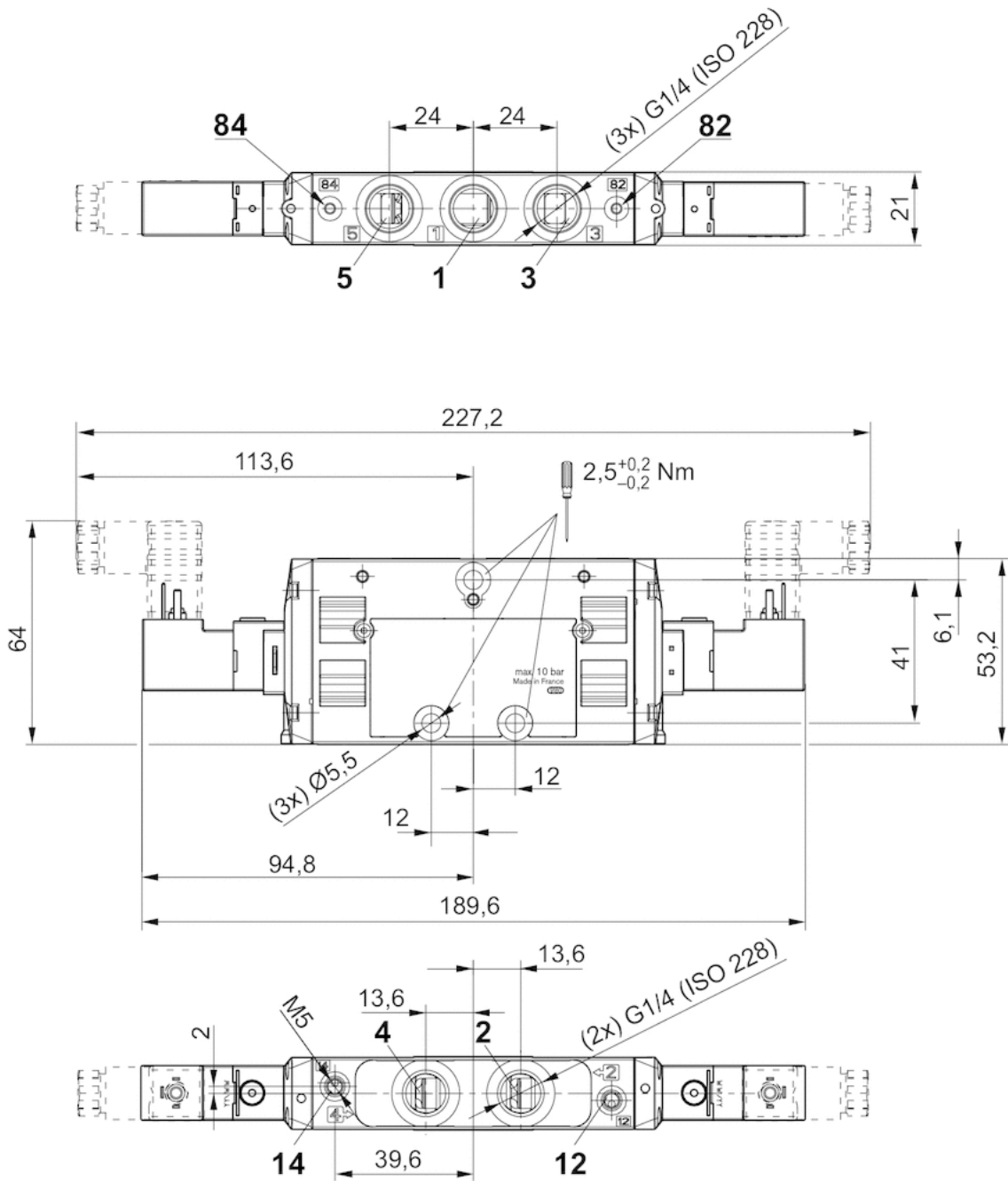

# Efficient pneumatic solutions, our program: cylinders and drives, valves and valve systems, air supply management



Visit us: [Emerson.com/Aventics](https://www.emerson.com/Aventics)

Your local contact: [Emerson.com/contactus](https://www.emerson.com/contactus)



[Emerson.com](https://www.emerson.com)



[Facebook.com/EmersonAutomationSolutions](https://www.facebook.com/EmersonAutomationSolutions)



[LinkedIn.com/company/Emerson-Automation-Solutions](https://www.linkedin.com/company/Emerson-Automation-Solutions)



[Twitter.com/EMR\\_Automation](https://twitter.com/EMR_Automation)

An example configuration is depicted on the title page. The delivered product may thus vary from that in the illustration. Subject to change. This Document, as well as the data, specifications and other information set forth in it, are the exclusive property of AVENTICS GmbH. It may not be reproduced or given to third parties without its consent. Only use the AVENTICS products shown in industrial applications. Read the product documentation completely and carefully before using the product. Observe the applicable regulations and laws of the respective country. When integrating the product into applications, note the system manufacturer's specifications for safe use of the product. The data specified only serve to describe the product. No statements concerning a certain condition or suitability for a certain application can be derived from our information. The information given does not release the user from the obligation of own judgement and verification. It must be remembered that the products are subject to a natural process of wear and aging.

The Emerson logo is a trademark and service mark of Emerson Electric Co. Brand logotype are registered trademarks of one of the Emerson family of companies. All other marks are the property of their respective owners. © 2020 Emerson Electric Co. All rights reserved.  
2020-12



**CONSIDER IT SOLVED™**